

**LIVERPOOL PLAINS, NSW
AIRBORNE GEOPHYSICAL SURVEY, 1995 -
OPERATIONS REPORT**

by

R. Franklin

**Australian Geological Survey Organisation
Record 1995/75**

DEPARTMENT OF PRIMARY INDUSTRIES AND ENERGY

Minister for Resources: The Hon. David Beddall, MP
Secretary: Greg Taylor

AUSTRALIAN GEOLOGICAL SURVEY ORGANISATION

Executive Director: Neil Williams

© Commonwealth of Australia

ISSN: 1039-0073

ISBN: 0 642 22386 6

This work is copyright. Apart from any fair dealings for the purposes of study, research, criticism or review, as permitted under the Copyright Act, no part may be reproduced by any process without written permission. Copyright is the responsibility of the Executive Director, Australian Geological Survey Organisation. Inquiries should be directed to the **Principal Information Officer, Australian Geological Survey Organisation, GPO Box 378, Canberra City, ACT, 2601.**

CONTENTS

SUMMARY

1. SURVEY AREA AND PARAMETERS	1
(i) Area Description	1
(ii) Survey Parameters.....	1
2. LOGISTICS	1
(i) Operating Base and Dates of Flying	1
(ii) Survey Aircraft and Field Crew	1
3. SURVEY EQUIPMENT	2
(i) Major equipment	2
(ii) Navigation	3
(iii) Magnetometer	4
(iv) Gamma-ray Spectrometer	4
(v) Altimeter	5
(vi) Barometer and Thermometer	5
(vii) Base Station Magnetometer	5
(viii) Data Acquisition	5
4. CALIBRATION	6
(i) Compensation for the Magnetic Field of the Aircraft.....	6
(ii) Gamma-ray Spectrometer Calibration	6
5. DATA PROCESSING	7
(i) Data Checking and Editing	7
(ii) Flight Path Recovery.....	7
(iii) Magnetic Data Processing.....	8
(iv) Gamma-ray Spectrometer Data Processing.....	9
(v) Digital Elevation Model Data Processing.....	12
(vi) Final Products	13
REFERENCES	15

APPENDICES

APPENDICES

- A. Survey Area
- B. Flying Dates and Line Kilometres Flown
- C. Real Time Differential GPS
- D. Specifications of G833 Helium Magnetometer
- E. Specifications of RMS Instruments Automatic Aeromagnetic Digital Compensator
- F. Specifications of Gamma-ray Spectrometer Components
- G. Specifications of G866 Base Station Magnetometer
- H. Aircraft Data Acquisition System
- I. Compensation Results
- J. Gamma-ray Spectrometer Test Line Location
- K. The Australian Geodetic Datum
- L. Corrections to Differential GPS Navigation Data
- M. Geophysical Maps
- N. AGSO Archive Data, Grid and Magnetic Tape Format for Airborne Geophysical Data

SUMMARY

As part of the National Environmental Geoscience Mapping Accord the Australian Geological Survey Organisation flew an airborne geophysical survey of 43 200 line km over an irregularly shaped area to the west of Tamworth, NSW from 13 February to 27 March 1995. The flight line direction was east-west and the line spacing was 200 m. Flying height was at an altitude of 80m above ground level.

This survey was specifically designed to help assess the extent of soil salinity, rising water tables and land degradation on the Liverpool Plains. The new datasets will provide the framework for future landuse and exploration and assist in developing strategies for environmental management and resource development.

The total magnetic intensity, gamma-ray spectrometric and digital elevation model data which were collected during the survey, have been processed and are available for purchase, in both digital (point located data and gridded) and map form, from the Australian Geological Survey Organisation. Colour and greyscale pixel image maps are also available.

1. SURVEY AREA AND PARAMETERS

(i) Area Description

The Nabberu North airborne survey covers the northern half of the Nabberu 1:250 000 Sheet of Western Australia. The exact survey area is shown in Appendix A.

Nabberu South was flown under an AGSO contract and this survey boundary is also shown in Appendix A.

This report covers the operations of the Nabberu North airborne survey. However where both airborne surveys may overlap some details are also given for the Nabberu South survey.

(ii) Survey Parameters

Nabberu North

Altitude	80 m nominal terrain clearance
Flight line direction	North-South
Tie line direction:	East-West
Survey Line spacing:	
Flight line spacing:	400 m
Tie line spacing:	4000 m

Survey distance flown:

Lines:	22084 km
Ties:	2310 km
Total distance:	25394 km

Sampling interval

Magnetics:	0.1 seconds (approx 7m)
Gamma-ray spectrometrics:	1.0 seconds (approx 67m)
GPS/Doppler/Altimeter	1.0 seconds (approx 67m)
Barometric pressure/Temperature:	10.0 seconds (approx 670m)

Nabberu South

Altitude	80 m nominal terrain clearance
Flight line direction	East-West
Tie line direction:	North-South
Survey Line spacing:	
Flight line spacing:	400 m
Tie line spacing:	4000 m

Survey distance flown:

Lines:	21965 km
Ties:	2276 km
Total distance:	24241 km

2. LOGISTICS

(i) Operating Base and Dates of Flying

(a) Operating Base

Aircraft and crew were based at Meekatharra, W.A. for the duration of the survey from 19 April to 14 May 1996.

(b) Flying Dates

A compensation flight for the magnetic field of the aircraft was flown on 19 April. Production flying commenced on 21 April and continued through to 14 May. Appendix B summarises flying days and distances flown.

(ii) Survey Aircraft and Field Crew

(a) Aircraft

Aero Commander 500 S "Shrike", VH-BGE

(b) Field Crew

Party Leader: Ross Franklin

Technicians: Dave Pownall

Trevor Dalziell

Operators: Lars Rickardsson

"Curly" Wilcox

Pilots: Capt. John Biffin (Skywest Aviation)

Capt. Marc Bourguignon(" ")

3. SURVEY EQUIPMENT

(i) Major Equipment

Magnetometer: Geometrics G833 helium magnetometer

Compensator: RMS Instruments Automatic Aeromagnetic Digital Compensator

Gamma-ray spectrometer: Exploranium gamma-ray spectrometer consisting of a GR820 spectrum processor and two DET1024 spectrometer crystal detectors (33.56 l total volume)

Altimeter: Collins ALT-50 radar altimeter

Barometer: AGSO digital-Setra sensor

Thermometer: AGSO digital-RS sensor

Navigation: Ashtech XII "Ranger" GPS receivers and Ashtech "Ranger" differential processing software.

Doppler Racal (Decca) doppler antenna (80561 CAD)
Sperry C 14 D compass

Video: National colour video camera (WV CL 302E)
National VCR (NV 180)
National LCD TV (TCL 3A)
National Time Date Generator (WJ 810)

Acquisition hardware: HP-A400 computer, HP9122 720 Kb 3.5 inch dual floppy disc drive and HP Thinkjet printer
Compaq Notebook and 120 Mb portable hard disk drive

Acquisition software: AGSO-developed HP assembler language program

(ii) Navigation

(a) GPS Navigation System

Navigation of the survey aircraft was by the real-time differential GPS method. Differential correction strings supplied by Starfix Pty Ltd were transmitted to a receiver in the aircraft. The aircraft navigation system used an Ashtech XII global positioning system (GPS) receiver which manipulated range data received from satellites every second and calculated the current latitude and longitude coordinates in the World Geodetic System 1984 (WGS84) of the aircraft. The range data were recorded internally in the GPS receiver every five seconds. GPS corrections to the range data from the base receiver were applied in real time. The real time method is described in Appendix C.

The calculated position of the aircraft was recorded on the aircraft acquisition system every second and was used to provide the pilot with aircraft guidance information on an LCD display.

Differential GPS post flight processing used a base GPS receiver which was set up in AGSO's field office caravan and internally recorded range data every five seconds. Data were post processed using Ashtech 'Ranger' software at the end of each flying day. The error in position of the post processed flight path data is approximately 5-10 metres. This was determined by flying over a known ground position from each of the cardinal directions.

The position of the base station GPS receiver was accurately determined by differential GPS surveying using Belele 10 trig, located approximately 18 km west of Meekatharra, as a fixed reference.

The determined base station GPS coordinates (WGS 84) were:

Longitude : 150°50'54.740' E

Latitude : 31°05'08.273' S
Ellipsoidal height : 452.7 m

The horizontal positions of the geophysical data from the survey are reported with respect to the WGS84 datum which is almost identical to the Geocentric Datum of Australia (GDA). It is intended that the GDA will be fully adopted in Australia by the year 2000. In the survey area there is an apparent translation in geographical position of 206 metres from AGD66 to WGS84.

(b) Doppler Navigation System

Doppler navigation data were used as a secondary navigation system for the aircraft. The doppler data were used as a back-up for the main navigation system (GPS) and to infill any gaps in the GPS data, none of which were more than 4 km.

(c) Video Flight Path Recording

The aircraft's flight path was recorded on a VHS video system consisting of a National colour video camera with a wide angle lens, a National VCR and a National LCD TV. This system was also used for locating start and end positions for the gamma-ray spectrometer test lines.

(iii) Magnetometer

A Geometrics G833 helium magnetometer, with the sensor mounted in a boom attached to the rear of the aircraft, was used for the survey. The specifications of the magnetometer are summarised in Appendix D.

The recorded total magnetic field data were compensated in real time using an RMS Instruments automatic aeromagnetic digital compensator (AADC). The AADC compensates for the effects of aircraft motion and heading. The specifications of the AADC are summarised in Appendix E. Compensation procedures are described in Chapter 4.

The AADC low pass filters the total magnetic field intensity data using a second order 0.9 Hz recursive Butterworth filter. The filtered compensated total magnetic field intensity data were recorded on the aircraft acquisition system.

(iv) Gamma-ray Spectrometer

An Exploranium gamma-ray spectrometer, incorporating two DET1024 crystal detectors with a total volume of 33.56 litres, was used. The crystal gains were controlled by an Exploranium GR820 spectrum processor. Appendix F summarises the specifications of the gamma-ray spectrometer components.

Two hundred and fifty six channels of data between 0.0 MeV and 3.0 MeV were recorded every second. These data were recorded on a portable hard disk via a communications link between the HP-A400 computer acquisition system and a Compaq Notebook computer.

Additionally five channels of data were recorded using the following window limits:

Total Count	0.40-3.00 MeV
Potassium	1.35-1.57 MeV
Uranium	1.63-1.89 MeV

Thorium	2.42-2.82 MeV
Cosmic	3.00-6.00 MeV

The Total Count, Potassium, Uranium and Thorium counts were used for data checking during acquisition and the Cosmic counts were used for background estimation and later data processing. A cumulative 256 channel spectrum between 0.0 MeV and 3.0 MeV was also recorded every 100 seconds. System live time (sample time - total dead time) was output with the data for later data processing.

(v) Altimeter

A Collins ALT-50 radar altimeter was used to measure ground clearance. The radar altimeter display indicates ground clearance from 0-2000 feet. The manufacturer's specifications claim a +/-2% accuracy for the ALT-50 system.

Prior to commencement of production flying the radar altimeter system was checked. This involved flying the aircraft at 30 metre height intervals, from 30 metres up to a height of 180 metres over Meekatharra airstrip using the aircraft's barometric altimeter as the height reference. Radar altimeter and GPS height data were recorded for each height interval flown. A comparison of these data with the aircraft's barometric altimeter verified that the system was operating satisfactorily.

(vi) Barometer and Thermometer

Atmospheric temperature and pressure were measured using a digital barometer (Setra sensor) and digital thermometer (RS sensor). Although both of these units were built by AGSO, the sensors were factory calibrated and no AGSO calibrations were performed.

(vii) Base Station Magnetometer

Daily variations of the Earth's magnetic field were monitored using a Geometrics G866 proton precession base station magnetometer, the specifications of which are given in Appendix G. The base station was set up in an area of shallow magnetic gradient, away from cultural influences and within telemetry range of AGSO's office caravan. Data from the base station were telemetered back to AGSO's field office caravan for display and recording on a Toshiba T1600 lap-top computer. The telemetry system used AGSO-built modems incorporating Phillips 828 UHF mobile radiotelephone transmit boards at a frequency of 471.8 MHz.

Throughout the survey, base station data were recorded every twenty seconds during production flights.

(viii) Data Acquisition

The acquisition program and system were run using a HP-A400 computer with data recorded on 3.5 inch floppy discs using a HP9122 720 Kb disc drive. The one-second multichannel spectra were recorded on a portable hard disk linked to the acquisition system through a Compaq Notebook computer.

The acquisition program was developed in-house at AGSO. The data are displayed in real time in the aircraft in analogue form on a HP Thinkjet printer. A schematic diagram of the aircraft's acquisition system is shown in Appendix H.

4. CALIBRATION

(i) Compensation for the Magnetic Field of the Aircraft

Compensation flights were flown in an area of low magnetic gradient prior to the start of the survey and after each aircraft service. They were flown at an altitude of 2930 m above sea level, approximately 48 kilometres northwest of Meekatharra over an area between 118°20' to 118°30'E and 26°20' to 26°30'S.

The compensation comprises a series of rolls($\pm 10^\circ$), pitches($\pm 5^\circ$) and yaws($\pm 5^\circ$) in the four cardinal headings to enable the AADC to calculate correction coefficients needed to remove aircraft manoeuvre noise. Each manoeuvre component was of 20 seconds duration.

The compensation manoeuvres were repeated after calculation of the coefficients to check the compensation quality. Peak-to-peak noise during repeat manoeuvres and after the final compensation was 0.30 nT or less. On normal survey flights, noise levels from all sources were generally less than 0.15 nT peak-to-peak.

The AADC calculates basic statistics which reflect the degree of merit of the compensation. These include the standard deviation of the recorded data without corrections applied, the standard deviation with the corrections applied, the improvement ratio (the ratio of the standard deviation of the recorded data without and with the corrections applied) and the vector norm (the degree of difficulty in calculating the corrections). These statistics are given for all compensations in Appendix I.

(ii) Gamma-ray Spectrometer Calibration

The GR820 spectrum processor uses a sophisticated automatic control method to maintain crystal alignment while stabilising on naturally occurring isotopes (typically Potassium). During operation the system continuously monitors each of the eight crystals signals and accumulates a separate spectra for each configured signal. When the confidence level for the selected stabilisation peak (Potassium) is exceeded, the peak channel of this isotope is computed, compared to the correct peak location, and the gain is then corrected.

Gamma-ray spectrometric test lines were flown at the beginning and end of each production flight. These lines were flown at survey altitude along a dirt road and lasted 150 seconds or approximately 10 kilometres. The location of the test lines used for the survey is shown in Appendix J.

Background corrections for gamma-ray data are calculated using a full spectrum method (Minty, 1992).

After each flight, statistics were calculated from data recorded between fixed reference points observed on video along the test line. These statistics were recorded in spreadsheet form and compared with the preceding flights in order to detect any irregularities. In particular, the difference between the average in the total count channel for the most recently flown test line and the running average of all the previously flown test lines was analysed. This value only rarely varied by greater than 10% for the test line, well inside a 15% variation which would be considered acceptable.

5. DATA PROCESSING

Flight path recovery, data checking and editing, and preliminary processing, gridding and imaging were performed at the survey base using the INTREPID airborne geophysical data processing and visualisation system. Final magnetic, gamma-ray spectrometric and digital elevation model data processing were carried out using in Canberra using INTREPID.

(i) Data Checking and Editing

Data recorded on the aircraft acquisition system were transferred on a flight by flight basis to a hard disk in a Compaq SLT386s/20 laptop computer. This computer was networked to a Sun Sparcstation IPX and all aircraft data were transferred to the Sun hard drive to be edited, using AGSO-developed software, for missing values, noise, spikes or steps. All the recorded data were displayed for each survey line and any errors were interactively corrected. Anomalies arising from cultural influences, such as sheds, houses and fences, were usually not edited out. They were only edited out if they caused severe noise or caused the magnetometer to lose lock.

(ii) Flight Path Recovery

Range data which were recorded internally every five seconds on both GPS receivers were post-processed daily in the field using "Ranger" - an Ashtech proprietary program. "Ranger" calculates the corrected flight path (longitude, latitude and height) relative to the WGS84 reference ellipsoid.

At the end of each flying day the corrected longitude and latitude data calculated at five second intervals by "Ranger" were used to correct the GPS data which were recorded every one second on the aircraft acquisition system. As well as the standard "Ranger" corrections, other acquisition system specific corrections were applied. Position data were retained in the WGS84 coordinate system, which is defined in Appendix K. The full correction procedure is described in Appendix L and is outlined below.

- (a) Position calculation delay correction.
- (b) Fiducial synchronisation correction.
- (c) "Ranger" corrections.
- (d) Low pass filter.
- (e) Reference navigation data to position of magnetometer sensor.
- (f) Doppler infill of gaps.

The fully corrected flight path was plotted each day to check the position of survey lines and their spacing. Navigation reflines were determined by the following criteria:

Line Spacing	Across Track Deviation	Distance along line
400 m	80 m	greater than 3 km

When both the across track deviation and along line distance were exceeded that portion of the survey line was reflight. This occurred very infrequently.

(iii) Magnetic Data Processing

Raw magnetic data were merged with the navigation data, and diurnal variation corrections were removed. The IGRF 1990 geomagnetic reference field, updated to May 1, 1995 and for an altitude of 300 m above sea level, which was estimated to be the mean survey altitude, was then subtracted from the data. The IGRF was calculated from the coefficients defined by the IAGA (1991). All magnetic values were adjusted by a constant so that the average residual magnetic field value was approximately 5000 nT.

The data were levelled using standard tie line levelling procedures. The steps involved in the tie line levelling were as follows.

- (a) Tie line 100 was chosen as a reference tie.
- (b) All other ties were levelled to this tie line using degree one polynomial adjustments.
- (c) Lines were adjusted on a flight by flight basis to minimise the differences at line/tie crossover points, using degree one polynomial adjustments.
- (d) Ties were then adjusted to minimise crossover differences, using degree one polynomial adjustments.
- (e) Finally the lines were adjusted individually to minimise crossover differences, using degree one polynomial adjustments.

The data were micro-levelled using the technique described by Minty (1991), using the following parameters.

- (a) Low pass filter in the flight line direction with a cut-off wavelength of 3200 metres.
- (b) High pass filter in the tie line direction with a cut-off wavelength of 800 metres.
- (c) Correction strings were low pass filtered with a cut-off wavelength of 500 metres before being applied to the line data. Adjustments were limited to a maximum of 30 nT, (94% of adjustments were less than 5 nT.)

Micro-levelling was repeated for the magnetic data using the following parameters.

- (a) Low pass filter in the flight line direction with a cut-off wavelength of 3200 metres.
- (b) High pass filter in the tie line direction with a cut-off wavelength of 1600 metres.

Correction strings were low pass filtered with a cut-off wavelength of 500 metres before being applied to the line data. Adjustments were limited to a maximum of 5 nT, (97% of adjustments were less than 1 nT.)

Nabberu South was flown by Kevron Geophysics concurrently with Nabberu North, as part of an AGSO contract airborne survey. Survey details for the Nabberu South survey were as follows:

Altitude	80 m nominal terrain clearance
Flight line direction	East-West
Tie line direction:	North-South
Survey Line spacing:	
Flight line spacing:	400 m
Tie line spacing:	4000 m

Gridded data for both surveys were stitched together to produce a combined grid. Nabberu North was used as the reference and correction grids were produced for the Nabberu South data. These corrections were removed from the Nabberu South data using the INTREPID micro-levelling tool to produce a combined dataset.

The final data were gridded using Brigg's minimum curvature technique, employing a 80 m (3") grid cell size.

(iv) Gamma-ray Spectrometer Data Processing.

The gamma-ray spectrometric data were processed using the multichannel processing method described by Minty (1996). The multichannel spectra were deadtime corrected, energy calibrated and background corrected. The spectra were then reduced to elemental count rates using a multichannel equivalent of the conventional 3-channel stripping. The elemental count rates were height corrected and converted to elemental concentrations on the ground in exactly the same way as for the 3-channel method.

The energy calibration was affected by using the positions of prominent photopeaks in the sum spectrum for each line to obtain an estimate of the energy at channel one and the gain (keV per channel). These parameters were then used to correct each spectrum in the line by resampling each channel to its correct energy range.

The three components of background were removed as follows.

- (a) Aircraft and Cosmic Background. Aircraft and cosmic spectra for the AGSO aircraft were determined from high altitude calibration flights using the procedure described by Minty and Richardson (1989).
- (b) Atmospheric Radon Background. A full spectrum method Minty (1996) was used to remove radon background. The method is based on the assumption that the observed spectrum (after correcting for aircraft and cosmic background) is the linear sum of the spectra due to K, U and Th in the ground and atmospheric radon. Since the shapes of these spectra can be determined through suitable calibrations, the atmospheric radon contribution to the observed spectrum can be estimated.

The energy-calibrated and background-corrected spectra were reduced to elemental count rates at the observation height by fitting K, U and Th component spectra in the energy range 0.515-3.0 MeV. The component spectra were determined from calibration experiments on the ground using wood to simulate the attenuation of gamma-rays by air. For full details of the multichannel method refer to Minty (1996).

The data were corrected for height attenuation and reduced to a nominal flying height of 80 m. Where the aircraft attained a height of 250 m or higher above the ground gamma-ray

spectrometric data have been set to undefined. Height attenuation corrections were made using the following formula

$$N_{\text{corrected}} = N_{\text{uncorrected}} e^{-u(H-h)}$$

where

$$N_{\text{corrected}} = \text{corrected counts}$$

$$N_{\text{uncorrected}} = \text{uncorrected counts}$$

$$H = \text{nominal flying height}$$

$$h = \text{measured flying height}$$

$$u = \text{attenuation coefficient}$$

Attenuation coefficients for each channel are given below

$$u_{\text{total count}} = 0.006354$$

$$u_{\text{potassium}} = 0.009084$$

$$u_{\text{uranium}} = 0.005967$$

$$u_{\text{thorium}} = 0.006145$$

Channel interaction corrections (stripping) to correct for Compton scattering were then applied to the data. Stripping ratios for the AGSO system were determined by Minty and others (1990) using portable calibration sources. The corrections were applied as follows

$$N_{\text{TH(corrected)}} = N_{\text{TH}}$$

$$N_{\text{U(corrected)}} = N_{\text{U}} - A \times N_{\text{TH(corrected)}}$$

$$N_{\text{K(corrected)}} = N_{\text{K}} - B \times N_{\text{TH}} - C \times N_{\text{U(corrected)}}$$

where

$$N_{\text{TH}} = \text{counts in the thorium channel}$$

$$N_{\text{U}} = \text{counts in the uranium}$$

$$N_{\text{K}} = \text{counts in the potassium channel}$$

$$A = 0.447 + 0.00046 * \text{height}$$

$$B = 0.399 + 0.00107 * \text{height}$$

$$C = 0.832 + 0.00109 * \text{height}$$

Gamma-ray spectrometric data were levelled in much the same way as the magnetic data. However, prior to sampling the crossover points, a 5 point convolution filter was passed over the data. Note that these filtered data were only used for the crossover analysis and the final point located data have not been filtered.

The steps involved in tie line levelling were as follows.

- (a) Tie line 240 was chosen as a reference tie.
- (b) All other ties were levelled to this tie using degree one polynomial adjustments.

- (c) Lines were adjusted on a flight by flight basis to minimise the differences at line/tie crossover points, using degree one polynomial adjustments.
- (d) Ties were then adjusted to minimise crossover differences, using degree one polynomial adjustments.
- (e) Finally the lines were adjusted individually to minimise crossover differences, using degree one polynomial adjustments.

The data were micro-levelled using the technique described by Minty (1991), using the following parameters.

- (a) Low pass filter in the flight line direction with a cut-off wavelength of 8000 metres.
- (b) High pass filter in the tie line direction with a cut-off wavelength of 800 metres.
- (c) Correction strings were low pass filtered with a cut-off wavelength of 250 metres before being applied to the line data. Adjustments were limited to a maximum of 100, 8, 6 and 12 counts/sec for Total Count, Potassium, Uranium and Thorium respectively, (92% of adjustments were less than 20 counts/sec for Total Count, 95% of adjustments were less than 2 counts/sec for Potassium, 90% were less than 2 counts/sec for Uranium and 96% of adjustments were less than 2 counts/sec for Thorium)

AGSO has moved to a new standard for reporting airborne gamma-ray spectrometric results. Potassium, uranium, and thorium data are reported as equivalent concentrations on the ground (%K, ppm eU, and ppm eTh). The sensitivity factors required to convert the airborne count-rates to elemental concentrations on the ground are determined from test flights over an airborne calibration range, (March 1996, Albury calibration range.) The conventional 'total count' is converted to estimates at ground level of the air-absorbed dose-rate (in nG/hr) due to natural sources of radiation. The corrected elemental count rates were converted to ground concentrations of K, U and Th using the expression:

$$C = \frac{N}{S}$$

where

- C = concentration of the radioelement (K%, U ppm or Th ppm);
- S = broad source sensitivity for the elemental count rate; and
- N = the fully processed elemental count rate (cps).

The broad source sensitivities were obtained from flights over a calibration range. The following sensitivities were used:

Potassium:	377.74 cps/%K
Uranium:	108.07 cps/ppm eU
Thorium:	56.63 cps/ppm eTh.

The total count was converted to the equivalent air-absorbed dose rate at ground level using the expression:

$$D = \frac{N}{F}$$

where

- D = the air absorbed dose rate (nGh^{-1});
- F = the conversion factor determined experimentally from flights over a calibration range ($23.14 \text{ cps/nGh}^{-1}$); and
- N = the total count rate (cps).

Nabberu South was flown by Kevron Geophysics concurrently with Nabberu North, as part of an AGSO contract airborne survey. Gridded data for both surveys were stitched together to produce combined grids.

Nabberu North was used as the reference and correction grids were produced for the Nabberu South data. These corrections were removed from the Nabberu South data using the Intrepid micro-levelling tool to produce a combined dataset.

The final data were gridded using Brigg's minimum curvature technique, employing a 80 m (3") grid cell size.

(v) Digital Elevation Model Data Processing.

As described in Chapter 5 - Section (ii), range data recorded internally every five seconds on both GPS receivers were post-processed on a daily basis using "Ranger" - an Ashtech proprietary program. "Ranger" calculates the position of aircraft GPS receiver's antenna, including longitude, latitude and height relative to the WGS84 reference ellipsoid for each set of range data (every five seconds).

As in the case of the longitude and latitude data, the following acquisition system specific corrections, which are described in Appendix L, are applied to the height data:

- (a) Position calculation delay correction.
- (b) Fiducial synchronisation correction.

The corrected height data, which are relative to the AGD84 reference ellipsoid, are then linearly interpolated to one second samples (70 metres) and are merged with the longitude and latitude data.

A radar altimeter provided the aircraft's ground clearance, the altimeter data being sampled every one second.

The raw ground elevation data were then calculated as the difference between the height of the aircraft above the ellipsoid and the height of the aircraft above the ground. These raw elevation data calculated every one second (70 metres) are relative to the WGS84 reference ellipsoid - the ellipsoid being a horizontal datum.

Elevation data were tie line levelled and the steps involved are described below.

- (a) Tie line 240 was chosen as the reference tie.

- (b) All other ties were levelled to the reference tie using degree one polynomial adjustments.
- (c) Lines were adjusted on a flight by flight basis to minimise the differences at line/tie crossover points, using degree two polynomial adjustments.
- (d) Ties were then adjusted to minimise crossover differences, using degree two polynomial adjustments.
- (e) Finally the lines were adjusted individually to minimise crossover differences, using degree two polynomial adjustments.

The data were micro-levelled using the technique described by Minty (1991), using the following parameters.

- (a) Low pass filter in the flight line direction with a cut-off wavelength of 5000 metres.
- (b) High pass filter in the tie line direction with a cut-off wavelength of 1600 metres.
- (c) Correction strings were low pass filtered with a cut-off wavelength of 250 metres before being applied to the line data. Adjustments were limited to a maximum of 6 metres, (92% of adjustments were less than 1 nT.)

The next step is to convert the heights relative to the WGS84 ellipsoid to heights relative to the geoid. The geoid, which is defined as "the equipotential surface of the gravity field which best approximates mean sea level", is usually chosen as the datum to which heights plotted on maps are referred. The height of the geoid above the AGD84 ellipsoid is called the geoid-ellipsoid separation or N value.

Geoid-ellipsoid separation information for the area covered by the Nabberu North Airborne Survey were supplied by the Australian Surveying and Land Information Group (AUSLIG). The set of N values were supplied as a 10 minute of arc (approximately 18 km) grid. AUSLIG also provides a program "DINTER" which uses bilinear interpolation to calculate N values on a one second of arc (approximately 1600 metres) grid. These values were then regridded using the new INTREPID imaging and data processing system to a cell size of 3.0 seconds of arc (approximately 80 metres). This grid of N values was then used to calculate correction strings to be subtracted from the elevation data. The correction strings were low pass filtered with a cut-off wavelength of 1000 metres before being applied to the point-located elevation data.

The elevation data were then corrected to account for the vertical separation between the antenna of the aircraft's GPS receiver, on the roof of the aircraft, and radar altimeter on the belly of the aircraft. This antenna separation distance of 1.675 metres was also subtracted from the elevation data.

Gridded data from the Nabberu South survey were stitched to the Nabberu North data to produce a combined grid.

Nabberu North was used as the reference and correction grids were produced for the Nabberu South data. These corrections were removed from the Nabberu South data using the Intrepid micro-levelling tool to produce a combined dataset.

The final data were gridded using Brigg's minimum curvature technique, employing a 80 m (3") grid cell size.

(vi) Final Products

(a) Standard AGSO geophysical maps

An AGSO standard set of geophysical maps have been produced at scales of 1:250 000 and 1:100 000 for the entire Nabberu Sheet. All maps were produced using the INTREPID processing system. The standard set of maps produced are shown in Appendix M.

(b) Digital Data

Final processed point-located data and grids were archived in the standard AGSO ARGUS format, on compact disc and magneto-optical discs, in ASCII format (Appendix M), and in ER Mapper format.

(c) Pixel Image Maps

Additional to the standard AGSO geophysical maps listed in AppendixM, pixel-image maps of the Nabberu have been compiled using the method described by Milligan and others (1992). The following pixel image maps have been released.

- (1) Colour 1:250 000 scale composite pixel-image of airborne gamma-ray spectrometry - Red (Potassium), Green (Thorium), Blue (Uranium).
- (2) Greyscale 1:250 000 scale pixel-image map of fractional vertical derivative of total magnetic intensity reduced to the pole.
- (3) Colour 1:250 000 scale pixel-image of total magnetic intensity reduced to the pole with illumination from the north.
- (4) Colour 1:250 000 scale pixel-image of the digital elevation model with illumination from the northeast.

References

Briggs, I.C., 1974 - Machine contouring using minimum-curvature. *Geophysics*, **39**, 39-48.

Grasty, R. L., 1975 - Uranium measurements by airborne gamma-ray spectrometry. *Geophysics*, **40**, 503-519.

International Association of Geomagnetism and Aeronomy, 1991 - Division V Working Group 8. International Geomagnetic Reference Field, 1991 Revision. *Journal of Geomagnetism and Geoelectricity*, **43**, 1007-1012.

International Atomic Energy Agency, 1991 - Airborne Gamma Ray Spectrometer Surveying. *International Atomic Energy Agency Technical Reports Series Number 323*, IAEA Vienna.

Milligan, P. R., Morse, M. P., and Rajagopalan, S., 1992 - Pixel map preparation using the HSV colour model. *Exploration Geophysics*, **23**, 219-224.

Minty, B.R.S., 1996. The analysis of multichannel airborne gamma-ray spectra. PhD thesis, Australian National University, September 1996.

Minty, B. R. S., Morse, M. P., and Richardson, L. M., 1990 - Portable calibration sources for airborne gamma-ray spectrometers. *Exploration Geophysics*, **21**, 187-195.

Minty, B. R. S., 1991 - Simple micro-levelling for aeromagnetic data. *Exploration Geophysics*, **22**, 591-592.

Minty, B. R. S., 1992 - Airborne gamma-ray spectrometric background estimation using full spectrum analysis. *Geophysics*, **57**, 279-287.

Minty, B. R. S., and Richardson, L. M., 1989 - Calibration of the BMR airborne gamma-ray spectrometer upward-looking detector, February 1989. *Bureau of Mineral Resources, Australia, Record 1989/8*.

APPENDIX A Survey Area

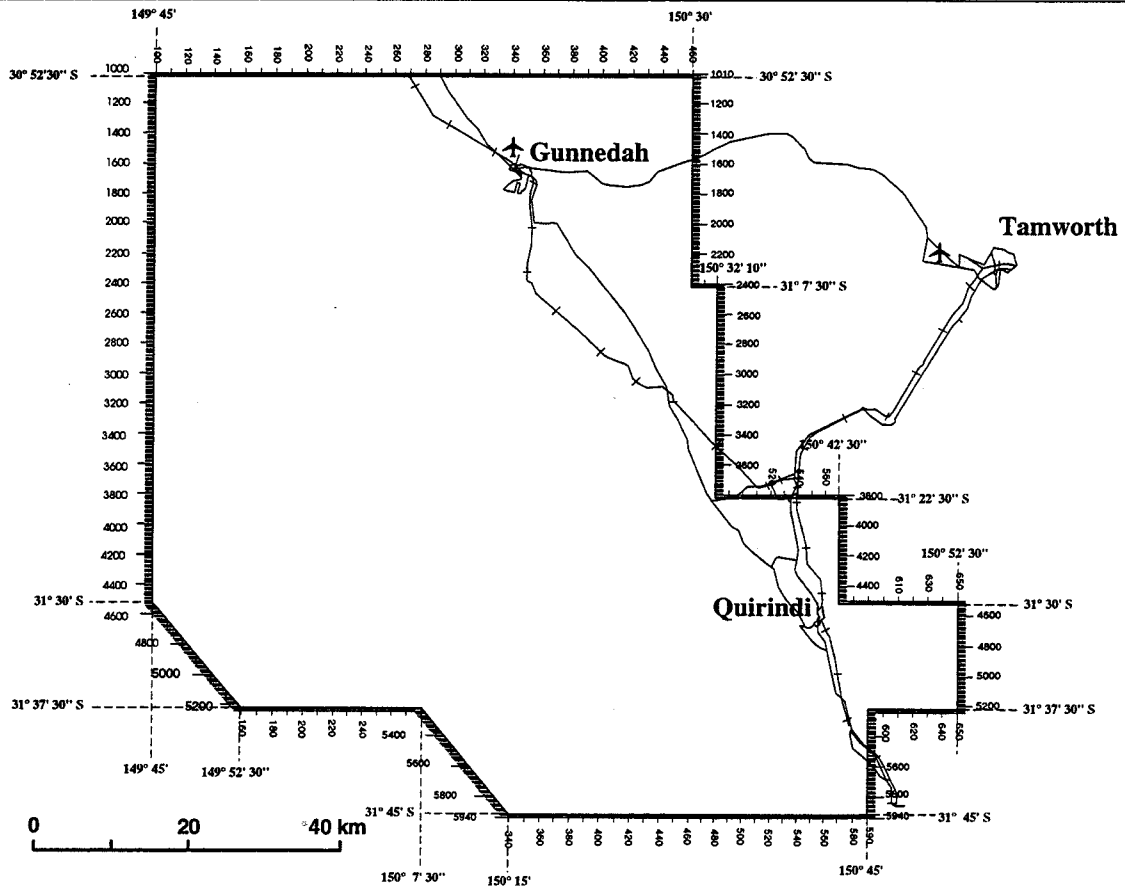

LIVERPOOL PLAINS SURVEY 1995

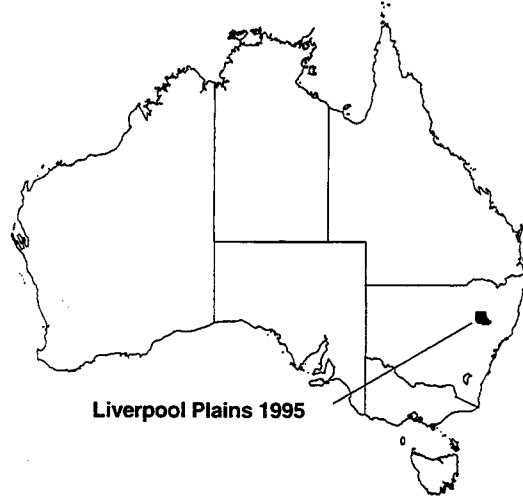

Liverpool Plains 1995

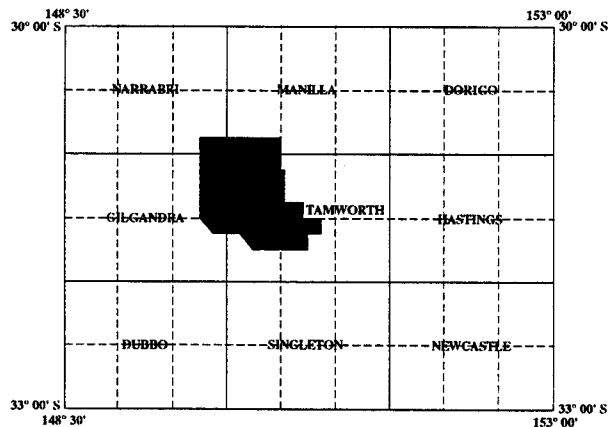

APPENDIX B-1

Flying Dates and Line Kilometres Flown

DATE	FLIGHT NUMBER	COMMENTS	LINE / TIE KILOMETRES
09/02/95		Ferry Canberra - Tamworth	
12/02/95	113	Compensation flight	
13/02/95	114	Compensation #1	
14/02/95	115	Operations normal	360
15/02/95	116	Operations normal	600
16/02/95	117	Operations normal	890
16/02/95	118	Operations normal	590
17/02/95	119	Operations normal	740
17/02/95	120	Operations normal	740
18/02/95	121	Operations normal	740
18/02/95	122	GPS cloverleaf & altimeter check	
19/02/94	123	Operations normal	740
19/02/95	124	Operations normal	740
20/02/95	125	Operations normal	660
20/02/95	126	Operations normal	740
21/02/95	127	Operations normal	890
22/02/95	128	Operations normal	740
23/02/95	129	Operations normal	890
24/02/95	130	Flight abandoned - alternator intermittent	150
24/02/95	131	Compensation #2	
25/02/95	132	Operations normal	780
25/02/95	133	Operations normal	930
26/02/95	134	Operations normal	780
26/02/95	135	Operations normal	930
27/02/95	136	Operations normal	780
27/02/95	137	Operations normal	930
28/02/95	138	Operations normal	780
28/02/95	139	Operations normal	930
01/03/95	140	Operations normal	780
01/03/95	141	Operations normal	930
02/03/95	142	Operations normal	930
03/03/95	143	Flight abandoned - high winds	150
04/03/95	144	Operations normal	620
05/03/95	145	Flight abandoned - high winds	390
08/03/95	146/7	Operations normal	670
09/03/95	148	Operations normal	890
09/03/95	149	Operations normal	750
10/03/95	150	Operations normal	940
11/03/95	151	Operations normal	750
11/03/95	152	Operations normal	940
12/03/95	153	Operations normal	640
12/03/95	154	Operations normal	750
13/03/95	155	Operations normal	750
13/03/95	156	Operations normal	780
14/03/95	157	Operations normal	840
15/03/95	158	Operations normal	620
16/03/95	159	Operations normal	760

APPENDIX C

REAL TIME DIFFERENTIAL GPS

Real time differential GPS navigation is used to improve navigational accuracy. Tracking using this method is more precise than by only using a single GPS receiver thus allowing a pilot to fly a line with less deviation.

The navigation equipment consisted of two Ashtech XII GPS receivers; one in the field office caravan (base) located at a known position at the Tamworth airport, and the other in the aircraft. The two identical GPS receivers were configured to run in differential mode.

The base station GPS calculated satellite range corrections which were transmitted to the aircraft by a UHF radio link. The base radio transmitter was a Philips PRM 8010 UHF radio, transmitting at 5 watts power through a UHF colinear antenna mounted about 10 meters above ground level.

The radio in the aircraft was a Philips PRM 8030 transceiver with a "voting" facility, which enables the receiver to search out and lock onto the strongest signal available. The receiving antenna in the aircraft was a ground-plane independent type, mounted on the top of the tail.

To extend the range of operation, two repeater stations for the telemetry system were used, each of which incorporated a pair of Philips PRM 8010 radios. The receiving antennas for the repeaters were a nine element Yagi aimed at the base transmitter, while the transmitting antennas were a colinear type mounted about 10 metres above the ground. One repeater was situated at Cana Trig (694 metres asl) and the other at Tambar Mountain (806 metres asl). Cana Trig was approximately 35 km south-west of the base and Tambar Mountain was approximately 105 km west of the base. With this configuration real time navigation was possible for the whole survey area.

The frequencies for the network were:

Tx from caravan.....490.175MHz.

Repeater from Cana Trig.....474.775MHz.

Repeater from Tambar Mountain.....490.525MHz.

The modems used to interface between the GPS receivers and the radios at the base station and in the aircraft were AGSO designed units incorporating TCM3105 chips operating at 1200 baud.

APPENDIX D - SPECIFICATIONS - G833 HELIUM MAGNETOMETER

Operating Range:	20,000 to 95,000 nT
Temperature:	-20 to +50°C
Sensitivity:	0.0032 nT/root Hz RMS
Bandwidth:	350 Hz (-3dB point)
Loop scan rate:	1000 cycles/second
Input power:	28 V DC, 6 A max.
Output signal:	At He gyromagnetic frequency, approximately 28.02468 Hz/nT. Three volts peak to peak
Dimensions:	Sensor cell - 80 mm diameter x 145 mm length Scan processor - 270 x 120 x 85 mm Control panel - 19 inch rack mount
Weight:	approximately 6 kg.

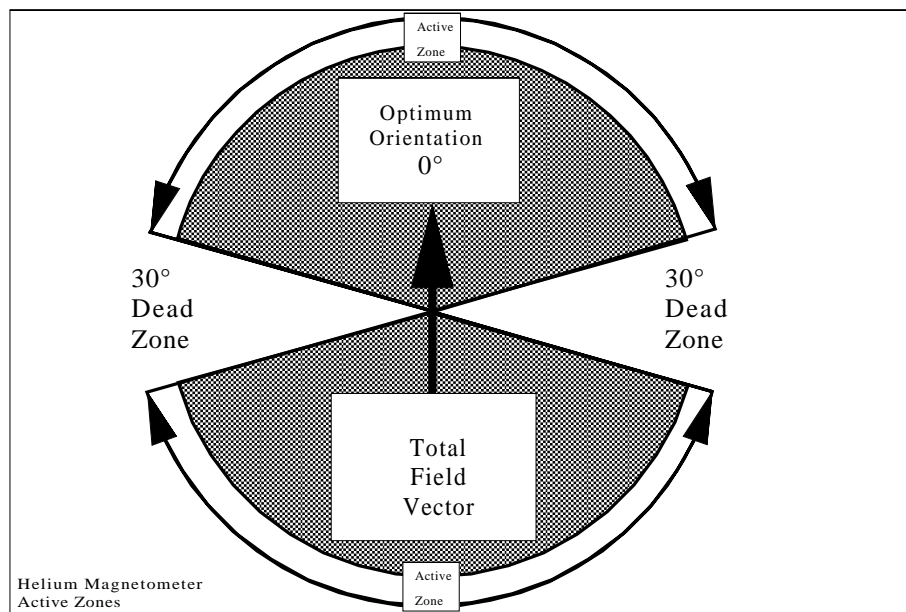

APPENDIX E-1

Specifications - RMS Instruments Automatic Aeromagnetic Digital Compensator

INPUTS:	one or two high sensitivity magnetometers of optical absorption type.
INPUT FREQUENCY RANGE:	70 KHz - 350 KHz - Cs sensor 140 KHz - 700 KHz - K sensor 560 KHz - 2800 KHz - He sensor 850 Hz - 4260 Hz - Overhauser
MAGNETIC FIELD RANGE:	20,000 - 100,000 nT (gamma)
RESOLUTION:	1 pT (picotesla)
COMPENSATION PROCEDURE:	improvement ratio 10 - 20 typical for total field improvement ratio 20 - 100 typical for gradient
ACCURACY OF COMPENSATION:	0.035 nT (gamma) standard deviation for the entire aircraft flight envelope in the bandwidth 0 - 1 Hz typical
DATA OUTPUT RATE:	10 Hz
SYSTEM FREQUENCY RESPONSE:	0 - 0.9 Hz
INTERNAL SYSTEM NOISE:	less than 2 pT (standard deviation in the bandwidth 0 - 1 Hz)
DURATION OF CALIBRATION: FLIGHT MANOUEVRES	5 - 8 minutes typical
VECTOR MAGNETOMETER:	Develco Model 9202-02 (3-axis fluxgate)
MICROCOMPUTER:	SBC-11/21 Plus (DEC) Front End LSI-11/73 (DEC) Main CPU
KEYBOARD:	limited alphanumeric
DISPLAY:	green fluorescent, 80 character self scan panel
OUTPUTS:	serial data communication port: RS232C - max. rate 19.2 K Baud parallel output port: 16 bit with full handshaking (DRV11-J) (optional)

APPENDIX E-2

Specifications - RMS Instruments Automatic Aeromagnetic Digital Compensator

POWER: 28 +/- 4 VDC, 5A, 150 W (for single magnetometer) 7A, 196 W (for gradiometer system)

ENVIRONMENTAL:

OPERATING TEMPERATURE: 0 to 50 degrees C

STORAGE TEMPERATURE: -20 to 55 degrees C

RELATIVE HUMIDITY: 0 - 99%, non-condensing

ALTITUDE: 0 - 6000 m (0 - 20,000 ft)

PHYSICAL DATA:

console dimensions: 483 x 178 x 440 mm

console weight: 12.5 kg

power supply dimensions: 225 x 180 x 220 mm

power supply weight: 5.5 kg

APPENDIX F-1

SPECIFICATIONS - GR820 SPECTROMETER SYSTEM

A. Detector Controller

- Maximum number of crystals - 16. Each crystal has individual pole-zero cancellation, semi-gaussian shaping and advanced base line restoration circuitry.
- Continuous, individual-crystal spectrum analysis ensures that optimum system stabilization is achieved. Resolution is calculated by a sophisticated gaussian curve fitting algorithm to perform an accurate centroid analysis of the selected stabilization peak.
- High energy cosmic pulses are accumulated in a separate channel.
- Accurate pile-up rejection for simultaneous pulses allows qualitative gamma-ray spectrum analysis almost independent of the system count rate. Special circuitry analyzes for pulse pile-up and permits only detector signals from single events to be analyzed. Simultaneous events in adjacent crystals are added to reduce the Compton effect.
- Residual pulse pile-up at 100,000 counts/sec are less than 2%.

B. Analog to digital converter (ADC)

- 50 mhz Wilkinson ramp ADC.
- Linearity - integral - less than 0.2% - differential - less than 1%.
- Average system dead-time is less than 5 microseconds/pulse.
- Live-time channel records the actual system live-time. This data is output with the digital data which allows post correction for system dead-time to an accuracy of 0.1%.
- Number of channels - selection of 256 channels or 512 channel operation.
- Maximum number of counts/channel - 65,535 (16 bits).
- The lower threshold - manually selectable from channel 2 to channel 50 (20-500 kev).
- The upper threshold is set to 3 Mev. All pulses above 3 MeV are accumulated in the cosmic channel as a direct measure of cosmic ray activity.
- ADC offset set from the keyboard.
- The maximum input count rate is 100,000 counts/second.

APPENDIX F-2

C. System outputs

- Visual display - the front panel display is a 640x200 electroluminescent (EL) high contrast graphics display which allows full spectrum display, system set-up and various parameter monitoring functions. In the spectrum display mode, the region of interest and cursor may be viewed by channel number or directly in keV.
- The internal channel number to energy level (keV) conversion table compensates for non-linearity of the detector's light output.
- The front panel has a 21 button keyboard for easy operator control.
- The system's operation is fully menu driven.
- Digital outputs
 - RS-232 port (1200 to 19200 baud).
 - IEEE-488 bus output - talk listen/talk only.
 - Geometrics GR-800 output format.
 - Some system functions can be controlled remotely by an external computer via the RS-232 and the IEEE-488 digital ports.
- Analog output
 - 4 channels of roi data can be selected for output on the analog port. The outputs have 10 bit resolution (0-10V). Scaling can be set from the keyboard (100-50K counts/sec FSD) and output data may be raw or stripped using internally stored calibration constants. Analog output wraps at fsd limits and is dead-time corrected.

D. Miscellaneous

- Regions of interest (ROI) 8 ROIs can be selected. The upper and lower thresholds can be individually set over the entire spectrum range.
- The first 4 ROIs are available for digital and analog output. The second 4 rois are available only for digital output on the RS-232 or the IEEE-488 ports.
- System resolution. Detector resolution is automatically computed for each (and summed crystals) during peak analysis and is displayed for operator monitoring when required. The summed down resolution is also output on the data stream.

System test. At power on, a full system test of all internal pcb handshaking is performed. Included in the testing is the lithium back-up battery, the system ram memory, display handshaking, the systems configuration (options installed), the selected detectors (checked via ADC analysis) and peripheral handshaking response.

APPENDIX F-3

- Configuration menus. The configuration menus allow the selection of the number of detectors in use, confidence levels for gain analysis, maximum crystal resolution levels for each detector (with operator warning if levels exceeded), output configurations for analog and digital data and various special display/monitoring functions.
- Maintenance. A set of special menus allows the user to test and calibrate many system functions including system test, ADC offset, low level discriminator etc.
- Power : 28V - 1.25 amps

E. Detectors

The crystals are housed in specially designed hi-impact polystyrene cases using low background materials for minimum signal attenuation. Full thermal and internal shock protection allows the units to be directly mounted to the floor. A very low noise, high voltage power supply is housed in each pack so high voltage is not present in the connecting cables. A unique preamplifier with special processing for signal optimization is used. The GPX-1024 has 4 crystals with a total volume of 16.78 litres

- Outputs. Individual BNC connectors output each crystal's signal separately.
- Size : GPX-1024 : 73x51x30 cms)
- Weight : GPX-1024 : 84 kg
- Power : 28 V @ 0.5 A/crystal pack

- Temperature limitations

Closed pack : storage -40 to +60, operation -40 to +60 deg. C

Open pack : not recommended

Temperature gradient

Closed pack : -40 to +50 (instantaneous)

Open pack : a change of 1 deg. C/hr.

APPENDIX G-1

SPECIFICATIONS - G866 BASE STATION MAGNETOMETER

Display: Six-digit, seven segment, numeric display of magnetic field with 0.1 gamma resolution. Same display used to set or view time-of-day and date, signal strength, battery voltage, and variables.

Resolution: Varies from 0.1 to 1 gamma depending on sample interval. 1 gamma for 0.5 to 0.9 second, 0.5 gamma for 1.0 to 1.7 seconds, 0.2 gamma for 1.4 to 2.9 seconds, and 0.1 gamma for 3.0 or more seconds.

Accuracy: one-half gamma.

Controls: Pressure-sensitive keyboard to control operation and to select variables. All control clock settings are stored in non-volatile memory, powered by lithium battery.

Clock: Julian clock with stability of 5 seconds per month at room temperature and 5 seconds per day over a temperature range of -20 to +50 degrees celsius.

Tuning: Push-button tuning from keyboard. Current tuning value displayed on request. Tuning range is 20 to 90 kilogammas.

Gradient Tolerance: Tolerates gradients to 5000 gammas/meter. When high gradients reduce signal quality, a partial reading is maintained at a resolution consistent with implied accuracy.

Sample Interval: Push-button selection of sample interval from 0.5 to 999.9 seconds. Resolution of 0.1 seconds.

Manual Read: Readings may be initiated by a front panel push-button.

External Cycling: Can be initiated by external cycling device.

Recorder: Electrosensitive recorder producing permanent records insensitive to heat, cold, sunlight or age. Chart width approximately 10 cm with the following formats available.

Narrow: Approximately one half of chart is an analog representation of every reading formed from closely connected dots in two overlapping scales. Remainder of chart is a numerical listing of periodic reading (e.g., every ninth reading) and time.

Wide Analog: The printed table may be deleted and the analog scale expanded when a high resolution analog chart is the preferred format (e.g., in magnetic search).

Variable "Chart Speed": Simulates changes in chart speed by varying time-axis spaces between plotted readings.

Recorder Scale: Four, push-button selected scales of 10/100, 20/200, 50/500 or 100/1000 gammas full scale. The analog records are dual range, as though there were two overlapping pens recording at different scale factors. The scales overlap by 20% with hysteresis so that there is no jitter at the scale edges.

Event Mark: A front panel push button or external input will cause an extra mark to be added for identification of special events.

APPENDIX G-2

SPECIFICATIONS - G866 BASE STATION MAGNETOMETER

Paper Feed: Advances paper rapidly for loading and unloading paper. Also causes the printer to annotate the record with sensitivity, scale factors, sample interval and date.

Special Functions: Internal switch, accessible by hinging up the front panel, allows selection of variations in operation:

- (a) Vary "chart speed" (see recorder).
- (b) Narrow chart (see recorder).
- (c) Wide analog chart (see recorder).
- (d) Power conservation. Display will automatically shut off 7 seconds after a reading has been taken, or two minutes after a key has been depressed.
- (e) 3-point running average (smooths data by taking running average).
- (f) 5-point running average (smooths data by taking running average).
- (g) 7-point running average (smooths data by taking running average).
- (h) Control disable (disable all front panel controls which might be used to modify the stored parameters, prevents operator errors), saves power.

Outputs: (1) BCD character serial output of time, day and field readings for use with external digital recorder. (Also outputs suitable handshaking signals for interfacing.) and (2) RS-232-C compatible ASCII output of time, day, and field reading: followed by a carriage return and line feed at three selectable baud rates (110, 300, 9600). This output is for an external printer or computer-based acquisition system.

APPENDIX H

Aircraft Acquisition System

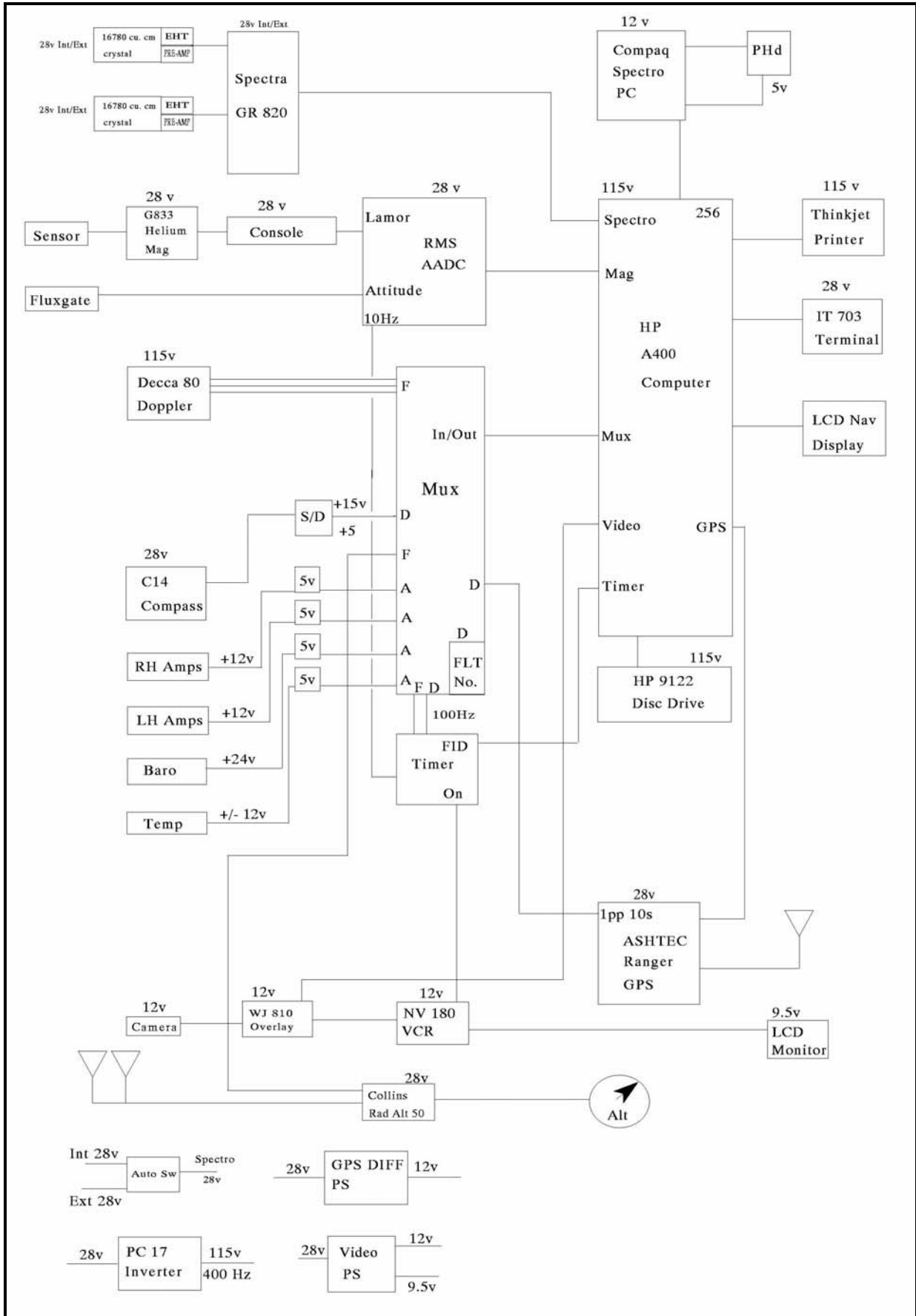

APPENDIX I-1

Compensation Results

COMPENSATION 1. Date flown: 13 February 1995

Air conditioner off	SDU = 0.4541
	SDC = 0.02911
	IR = 15.6
	VN = 19.9

Air conditioner on	SDU = 0.4825
	SDC = 0.08025
	IR = 6.0
	VN = 21.8

COMPENSATION 2. Date flown: 24 February 1995

Air conditioner off	SDU = 0.4535
	SDC = 0.03374
	IR = 13.4
	VN = 20.9

Air conditioner on	SDU = 0.4693
	SDC = 0.03535
	IR = 13.3
	VN = 19.1

SDU = Standard deviation of the data recorded during manoeuvres.

SDC = Standard deviation of the data recorded during manoeuvres after compensation corrections have been applied.

IR = Improvement ratio = SDU / SDC

VN = Vector Norm, a measure of the degree of difficulty in calculating the coefficients.

APPENDIX J
Gamma-ray Spectrometer Test Line Location

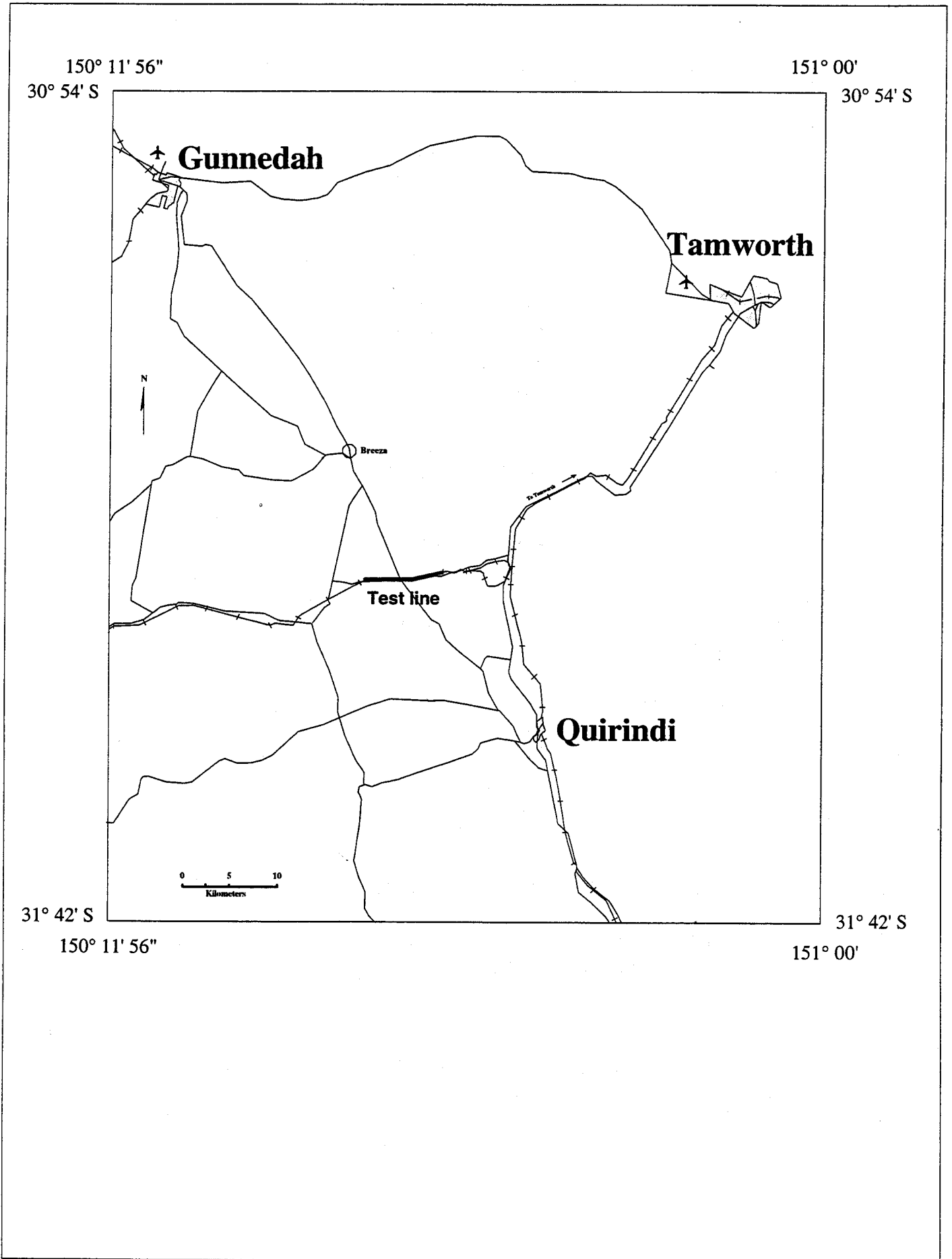

APPENDIX K

The Australian Geodetic Datum

For geophysical surveys the real shape of the earth has to be considered. An ellipsoid of revolution around the earth's north-south axis approximates the earth's shape. This figure is called the spheroid. The mean sea level equipotential surface describing the shape of the earth is known as the geoid.

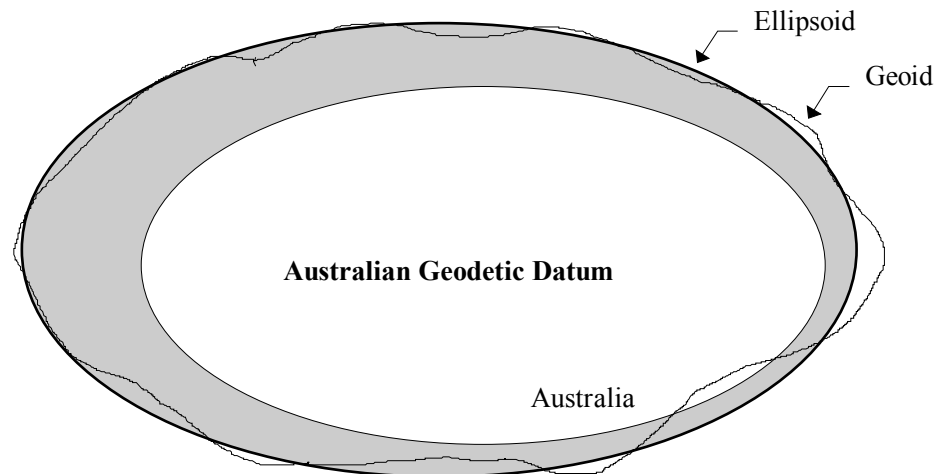

Calculated positions from the GPS are in the World Geodetic System 1984 (WGS84). The WGS84 datum is a global geocentric reference datum that has as its origin the Earth's centre of mass. The non-geocentric datum which comprises the Australian National Spheroid (ANS) is oriented and located in such a manner as to "best-fit" the geoid over the Australian continent.

The WGS84 datum is almost identical to the Geocentric Datum of Australia (GDA). It is intended that the GDA will be fully adopted in Australia by the year 2000.

The WGS84 datum is defined by a semi-major axis (a) and flattening (f) of the selected ellipsoid.

$$\begin{array}{lcl} a & = & 6378137 \text{ m} \\ f & = & 1/298.2572 \end{array}$$

There is an apparent translation in geographical position over the survey area of 206 metres when converting from WGS84 to AGD66.

APPENDIX L

Corrections to Differential GPS Navigation Data

(a) Position calculation delay correction

A correction due to the finite time taken for the GPS system to calculate a position and transfer the information to the acquisition system. A delay of 0.6 seconds has been determined for calculations using up to eight satellites by flying clover leaf patterns over a reference point. This value is considered to be representative and was used for all delay corrections.

(b) Fiducial synchronisation correction

A correction due to the time lag between when a GPS position is available to the acquisition system and when the next fiducial is available to pair the position with.

(c) "Ranger" corrections

Using the range data which are recorded internally on both GPS receivers every five seconds, "Ranger" calculates the correct positions at five second intervals along the flight path. These corrected positions are utilised when correcting the aircraft raw position data which are recorded every second.

Discontinuities (steps) sometimes occur in raw GPS data. These are also manifested as steps in the correction set.

When such steps in the raw GPS data occur between successive correction values, the corrections are linearly interpolated to the step boundary using corrections from the appropriate side of the step.

If multiple steps in the raw GPS data occur between successive correction values it is impossible to interpolate corrections over this interval, in which case the intervening GPS data are set to undefined.

(d) Low pass filter

The problem described in (c) can lead to small steps in the data where the original steps were too small to detect so were not corrected. A low pass 11 point convolution filter with a cut-off wavelength of 300 m was passed over the data.

(e) Reference navigation data to position of magnetometer sensor

The calculated GPS positions refer to the position of the GPS receiver's antenna. Since the magnetometer is the most position sensitive instrument, all position data is shifted 11.4 meters toward the rear of the aircraft to correspond with the position of the magnetometer's sensor.

(f) Doppler infill of gaps

Whenever gaps (<10 km) in the GPS data occurred they were infilled with data generated from the doppler navigation system. Gaps in the GPS data greater than ten kilometres were reflown.

APPENDIX M

Geophysical Maps

Name	Type	Contour Interval / Vertical Scale	Reference Number
1:250 000 scale			
Liverpool Plains	TMI Contours	25 nT	22-1/H56-13/1
"	TC Contours	100 cps	22-1/H56-13/2
"	DEM Contours	10 m	22-1/H56-13/19
1:100 000 scale			
Liverpool Plains North 1N	TMI Contours	10 nT	22-2/H56-13/1-
"	TC Contours	50 cps	22-2/H56-13/2-
"	Flight Path		22-2/H56-13/3-
"	TMI Profiles	800 nT/cm	22-2/H56-13/4-
Liverpool Plains South 1S	TMI Contours	10 nT	22-2/H56-13/1-
"	TC Contours	50 cps	22-2/H56-13/2-
"	Flight Path		22-2/H56-13/3-
"	TMI Profiles	800 nT/cm	22-2/H56-13/4-

APPENDIX N-1

AGSO ARCHIVE DATA, GRID AND MAGNETIC TAPE FORMAT FOR AIRBORNE GEOPHYSICAL DATA

CONTENTS

1. THE AGSO SEQUENTIAL FILE STRUCTURE
 - 1.1 INTRODUCTION
 - 1.2 GENERAL FILE STRUCTURE
 - 1.3 CHANNELS AND SAMPLES
 - 1.4 SEGMENT DIRECTORY RECORD
 - 1.5 DATA RECORD
 - 1.6 NO DATA VALUE
 - 1.7 STANDARD DATA CHANNELS

2. PHYSICAL FORMAT FOR MAGNETIC TAPES
 - 2.1 GENERAL
 - 2.2 PHYSICAL PARAMETERS OF TAPE
 - 2.3 TAPE STRUCTURE
 - 2.4 PHYSICAL RECORDS AND BLOCKS

3. GRID FILE FORMAT
 - 3.1 HEADER RECORD
 - 3.2 DATA RECORDS

TABLES

FIGURES

APPENDIX N-2

AGSO ARCHIVE DATA, GRID AND MAGNETIC TAPE FORMAT FOR AIRBORNE GEOPHYSICAL DATA

1. THE AGSO SEQUENTIAL FILE STRUCTURE

1.1 INTRODUCTION

This appendix describes the general sequential file structure used by AGSO to store airborne geophysical data. For the purpose of this survey ten data chains are involved for each line and tie. They are:

- channel 4 edition 1 (processed navigation)
- channel 4 edition 2 (processed magnetics)
- channel 4 edition 3 (processed spectrometrics)
- channel 4 edition 4 (processed digital elevation model)
- channel 5 edition 1 (doppler)
- channel 6 edition 1 (raw spectrometrics)
- channel 8 edition 1 (raw magnetics)
- channel 10 edition 1 (multi-channel spectra)
- channel 14 edition 1 (pressure,temperature,cosmic data)
- channel 16 edition 1 (raw navigation)

1.2 GENERAL FILE STRUCTURE

The information pertaining to each traverse (line or tie) is held on the file as a separate entity called a segment. Segments are separated from each other by industry standard EOF records. The end of the file is indicated by two or more consecutive EOF records. Each segment consists of two types of records. Both types are 5120 characters long.

1. Segment Directory Record (SDR) : the first record on each segment. It defines the data content of the segment.
2. Data Records (DAR's) : hold the measured data values. The general structure is shown in Figure 1.

1.3 CHANNELS AND SAMPLES

Data are recorded at regular intervals in time along a traverse. The data recorded at one instant of time are held as any ordered set or sub-set. Each set is held logically distinct and referred to as a channel. The data records in a segment hold all the information for one channel in the form of a data chain, then all the data for the next channel and so on for as many channels as the segment holds.

Each channel is uniquely defined by a channel number and an edition number. The measurement(s) taken for a channel at a given time is called a sample. Samples are held within each channel in increasing order of fiducial (time).

In defining channels the channel number can be used to define the sample format and the edition type of the data. For example, within AGSO, samples with format (longitude, latitude,

APPENDIX N-3

AGSO ARCHIVE DATA, GRID AND MAGNETIC TAPE FORMAT FOR AIRBORNE GEOPHYSICAL DATA

value, value...) have a channel number of 4 with edition 2 for magnetics and edition 3 for radiometrics.

1.4 SEGMENT DIRECTORY RECORD (SDR)

Lines and ties are uniquely identified as follows :

1. Project number: a unique number to identify the survey.
2. Group number : a unique number within a survey for each flight made. That is, several lines may be recorded on one flight (group). AGSO convention is for group numbers to lie between 001 and 999 inclusive.
3. Segment numbers : a unique number within a survey for a line or tie. AGSO convention is for ordinary line numbers to lie between 1000 and 9999 inclusive and tie line numbers between 100 and 999 inclusive.

The segment directory record identifies the data segment at Project, Group and Segment level and defines the data channels, their structure and the location of their data chains in the segment. Each SDR consists of one or more 10 word blocks. The first, the Segment Identification Block (SIB), identifies the segment and gives the number of data channels held in the segment.

For this survey the number of data channels is ten as mentioned in the introduction. Subsequent blocks, one for each data channel, define the data channels and their location within the segment. These are called Channel Identification Blocks (CIB's). A typical SDR is shown in Figure 1 and its exact format given in Table 1. All unused words in the SDR are set to zero.

The last word in the record in the past has been used as a check sum and represents the sum of all the other words in the record. The check sum word is no longer used and is set to zero.

The overall record format is 2I9, 509I10, I12.

1.5 DATA RECORD (DAR)

These each contain 512 values. The first two are fiducials giving the fiducial range of the samples contained in the record. The next 508 represent data values, the second last is always zero (to maintain compatibility with our random access file format) and the last is a record check sum representing the sum of all other values in the record.

If a record is the last one in a data chain for a given channel all unused values are set to zero, with the next channel commencing at the start of the next data record. The N data records in a segment are numbered from 2 to N+1, the SDR being regarded as record one in a segment, with records for a given channel following each other sequentially. The data record addresses in the channel identification block of the SDR refer to this sequential numbering of the data records. A typical segment is shown in Figure 1 and the exact format of a data record given in Table 2.

APPENDIX N-4

AGSO ARCHIVE DATA, GRID AND MAGNETIC TAPE FORMAT FOR AIRBORNE GEOPHYSICAL DATA

The overall format of each data record is : 2I9, 509I10, I12.

1.6 NO DATA VALUE

For a variety of reasons it is sometimes necessary to flag a data value to indicate it is to be ignored. This is achieved by replacing the data word in question by the value 536870912. If a gap exists in a data chain each word of every sample involved must be replaced by 536870912, the so-called missing value. Thus a 1:1 correspondence is maintained between the fiducials encompassed by a data chain and its samples.

1.7 STANDARD DATA CHANNELS

The standard AGSO data channels are :

- channel 4 edition 1 (processed navigation)
- channel 4 edition 2 (processed magnetics)
- channel 4 edition 3 (processed spectrometrics)
- channel 4 edition 4 (processed digital elevation model)
- channel 5 edition 1 (doppler)
- channel 6 edition 1 (raw spectrometrics)
- channel 8 edition 1 (raw magnetics)
- channel 10 edition 1 (multi-channel spectra)
- channel 14 edition 1 (pressure,temperature,cosmic data)
- channel 16 edition 1 (raw navigation)

C4 E1 - Navigation

Channel number = 4

Edition number = 1

Sample size = 2 words

word 1 = Longitude in degrees * 1 000 000

word 2 = Latitude in degrees * 1 000 000

APPENDIX N-5

AGSO ARCHIVE DATA, GRID AND MAGNETIC TAPE FORMAT FOR AIRBORNE GEOPHYSICAL DATA

C4 E2 - Corrected Total Magnetic Intensity

Channel number = 4

Edition number = 2

Sample size = 4 words

word 1 and word 2 as for C4 E1

word 3 = final (non micro-levelled) TMI (nT) * 1000

word 4 = final micro-levelled TMI (nT) * 1000

C4 E3 - Corrected Gamma-ray Spectrometer Data

Channel number = 4

Edition number = 3

Sample size = 7 words

word 1 and word 2 as for C4 E1

word 3 = final Total Count (counts/sec) * 1000

word 4 = final Potassium (counts/sec) * 1000

word 5 = final Uranium (counts/sec) * 1000

word 6 = final Thorium (counts/sec) * 1000

word 7 = Altitude in metres above ground level

C4 E4 - Corrected Digital Elevation Model Data

Channel number = 4

Edition number = 2

Sample size = 4 words

word 1 and word 2 as for C4 E1

word 3 = final Aircraft Elevation (metres above sea level) * 100

word 4 = final Terrain Elevation (metres above sea level) * 100

C5 E1 - Doppler navigation data

Channel number = 5

Edition number = 1

Sample size = 2 words

word 1 = doppler along track (km)

word 2 = doppler across track (m)

C6 E1 - Raw spectrometer data, Raw VLF data.

Channel number = 6

Edition number = 1

Sample size = 7 words

word 1 = Total count (counts/sec) * 1000

word 2 = Potassium (counts/sec) * 1000

word 3 = Uranium (counts/sec) * 1000

word 4 = Thorium (counts/sec) * 1000

word 5 = Altitude in metres above ground level

word 6 = VLF Total Field (% of primary field)

word 7 = VLF Vertical Quadrature (% of primary field)

C8 E1 - Raw Magnetics

APPENDIX N-6

AGSO ARCHIVE DATA, GRID AND MAGNETIC TAPE FORMAT FOR AIRBORNE GEOPHYSICAL DATA

Channel number = 8
Edition number = 1
Sample size = 1 word
word 1 = TMI * 1000

C10 E1 - Multi-channel spectra

Channel number = 10
Edition number = 1
Sample size = 290 words
word 1 = start fiducial for spectra
word 2 = integration time for spectra (seconds)
word 3 - 34 = define energy range of spectra, fiducials etc.
Some control words yet to be defined.
word 35 = counts in channel 0 (* 1000)
word 36 = counts in channel 1 (* 1000)
word 290 = counts in channel 255 (* 1000)

C14 E1 - Pressure and Temperature

Channel number = 14
Edition number = 1
Sample size = 7 words
word 1 = pressure in millibars * 10
word 2 = temperature in degrees celsius * 10
word 3 - 6 = no longer used
word 7 = cosmic channel (counts) * 1000

C16 E1 - Raw GPS data

Channel number = 16
Edition number = 1
Sample size = 4 words
word 1 = Longitude in degrees * 1 000 000
word 2 = Latitude in degrees * 1 000 000
word 3 = GPS time in seconds * 1000.
GPS time is recorded in seconds from midnight the previous Sunday
word 4 = Lag time. Time difference between time when a position is calculated and time until the next fiducial is generated by the data acquisition system. (hundredths of a second)

2. PHYSICAL FORMAT FOR MAGNETIC TAPES

2.1 GENERAL

Each magnetic tape (MT) consists of a sequence of segments, each segment consisting of one or more physical records. Segments are to be separated by one EOF markers. The end of all information on a tape must be flagged by two or more consecutive EOF markers. Industry standard EOF records apply. Records are to be fixed length and each block is to contain one record.

APPENDIX N-7

AGSO ARCHIVE DATA, GRID AND MAGNETIC TAPE FORMAT FOR AIRBORNE GEOPHYSICAL DATA

2.2 PHYSICAL PARAMETERS OF TAPES

- a. Tapes are 12.7 mm (0.5 inch) wide, 9 track industry standard magnetic tapes.
- b. Each tape has an external label identifying the airborne survey, character code, recording density, date tape written and the reel number in the set.

2.3 TAPE STRUCTURE

- a. 9 track
- b. Written in ASCII
- c. Recording density of 6250 bpi
- d. International Standards Organisation end-of-block markers (EOB)
- e. International Standards Organisation end-of-file markers (EOF)
- f. No multi-tape files
- g. Multi-file tapes can be expected. Files will not span tapes.
- h. Last file on each tape shall end with at least two EOF's.

2.4 PHYSICAL RECORDS AND BLOCKS

- a. Fixed length records of 5120 characters
- b. One record per block

3. GRID FILE FORMAT

3.1 HEADER RECORD

The first record on the file defines the content of the grid, including:

- a. Origin in latitude and longitude.
- b. Grid cell size.
- c. Number of rows and columns in the grid.
- d. Storage mode, i.e. whether the data is stored row by row or column by column. In general the data is stored by row.
- e. The exact header record format is in Table 3.

3.2 DATA RECORDS

Each data record contains 320 values in E16.10 format. No location data is held in the data records - the location of a grid point is determined by its sequence within the file. The data for the grid may be sequenced in row or column order (i.e. row by row or column by column respectively). Each row or column is written on consecutive records and begins at the start of a new record. If the rows/columns do not contain a multiple of 320 values the last record for each row/column is padded with zeros. Any point in the grid which is undefined is set to -9999.0.

APPENDIX N-8

AGSO ARCHIVE DATA, GRID AND MAGNETIC TAPE FORMAT FOR AIRBORNE GEOPHYSICAL DATA

In ROW mode , rows are sequenced from north to south and within each row values are ordered from west to east.

In COLUMN mode, columns are sequenced from west to east and within each column values are ordered from north to south.

APPENDIX N-9

AGSO ARCHIVE DATA, GRID AND MAGNETIC TAPE FORMAT FOR AIRBORNE GEOPHYSICAL DATA

TABLE 1

SEGMENT DIRECTORY RECORD FORMAT

1. SEGMENT IDENTIFICATION BLOCK

WORD	CONTENT AND USE	FORMAT
1	PROJECT IDENTIFICATION	I9
2	GROUP IDENTIFICATION	I9
3	SEGMENT IDENTIFICATION	I10
4	NUMBER OF CHANNELS ON SEGMENT	I10
5	DATE CODE - YYMMDD	I10
6	FIDUCIAL FACTOR - (fiducial size in seconds)	I10
7	TIME OF DAY AT FIDUCIAL ZERO IN SECONDS	I10
8	BEARING IN DEGREES (0-359) MEASURED EAST OF NORTH	I10
9	ALTITUDE IN METRES ABOVE SEA LEVEL	I10
10	GROUND CLEARANCE IN METRES	I10

2. CHANNEL IDENTIFICATION BLOCK (for the Nth channel)

WORD	CONTENT AND USE	FORMAT
1	CHANNEL CODE	I10
2	EDITION NUMBERS	I10
3	FIDUCIAL INTERVAL BETWEEN SAMPLES	I10
4	NUMBER OF DATA VALUES (WORDS) PER SAMPLE	I10
5	ADDRESS OF FIRST DATA RECORD FOR CHANNEL	I10
6	ADDRESS OF LAST SAMPLE IN DATA CHAIN	I10
7	FIDUCIAL OF FIRST SAMPLE IN DATA CHAIN	I10
8	FIDUCIAL OF LAST SAMPLE IN DATA CHAIN	I10
9	UNUSED - SET TO ZERO	I10
10	UNUSED - SET TO ZERO	I10

APPENDIX N-10

AGSO ARCHIVE DATA, GRID AND MAGNETIC TAPE FORMAT
FOR AIRBORNE GEOPHYSICAL DATA

TABLE 2

DATA RECORD FORMAT

WORD	CONTENT AND USE	FORMAT
1	FIDUCIAL AT FIRST DATA SAMPLE IN RECORD	I9
2	FIDUCIAL AT LAST DATA SAMPLE IN RECORD	I9
3	FIRST WORD OF FIRST SAMPLE	I10
4	SECOND WORD OF FIRST SAMPLE	I10
	FIRST WORD OF SECOND SAMPLE	I10
	SECOND WORD OF SECOND SAMPLE	I10
	ETC	
511	ALWAYS UNUSED - SET TO ZERO	I10
512	ALWAYS UNUSED - SET TO ZERO	I12

- NOTE:
1. A data sample can be of any length greater than zero.
 2. Each record contains an integral number of samples. This may lead to several unused words at the end of the record which are set to zero.

i.e. If a sample is 7 words long 72 samples will fit in a data record and words 507-510 will be set to zero.

APPENDIX N-11

AGSO ARCHIVE DATA, GRID AND MAGNETIC TAPE FORMAT FOR AIRBORNE GEOPHYSICAL DATA

TABLE 3

GRID HEADER RECORD FORMAT

CHARACTER POSITION	FIELD LENGTH	FORTRAN FORMAT	CONTENT
1-60	60	6A10	Grid Identification
61-170	10	11A10	Facts defining data acquisition/processing
171-180	10	A10	x,y units defining grid, Usually degrees.
181-192	12	E12.6	x origin of surface. Bottom left hand corner.
193-204	12	E12.6	y origin of surface. Bottom left hand corner.
205-214	10	A10	Type of z data in grid (e.g. TMI).
215-216	2	A2	Blanks.
217-228	12	I12	Number of data records per column or row.
229-240	12	E12.6	Grid increment in the x direction
241-252	12	E12.6	Grid increment in the y direction
253-262	10	A10	Time when original surface created (hh.mm.ss).
263-286	24	2A10,A4	Filter used on original z data.
287-310	12	2E12.6	x,y co-ordinate of the bottom left hand corner of the grid. Same as x,y origin.
311-320	10	A10	Date of creation of surface (dd/mm/yy).
321-344	24	2A10,A4	Blanks.
345-368	12	2E12.6	x,y co-ordinate of top right hand corner of grid. NOTE: these values are too large by one grid increment for tapes created prior to 01/06/85.
369-373	5	I5	Number of rows in the grid.
374-378	5	I5	Number of columns in the grid.
379-382	4	A4	Blanks.
383-388	6	A6	Defines if the grid is stored in column mode (COLUMN) or row mode (ROW).
389-5120			Blank filled.